

53.59mm

72.39mm

**MEGAWIN**  
MG82FG5B32  
LQFP32\_V11  
Ev Board  
TH156B

**ICE/ICP**  
RST GND SDA VDD SCL P30

**ISP**  
GND P31 VDD

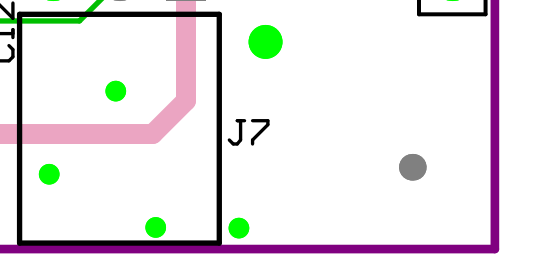
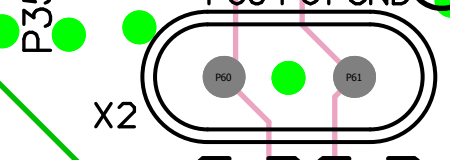
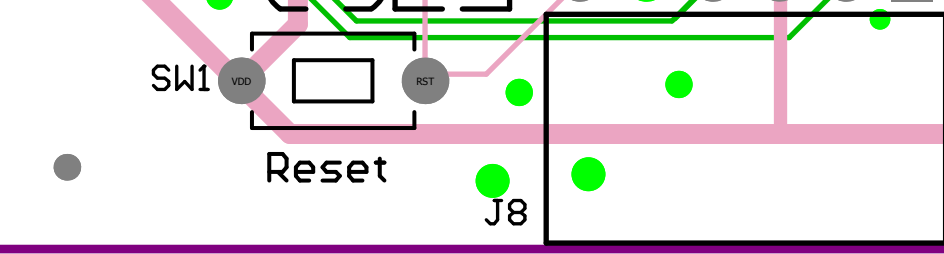
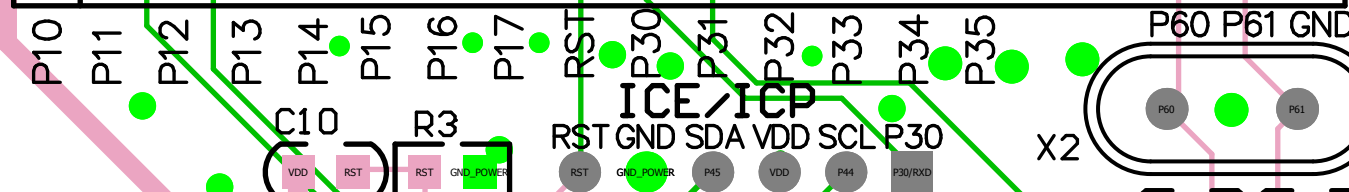
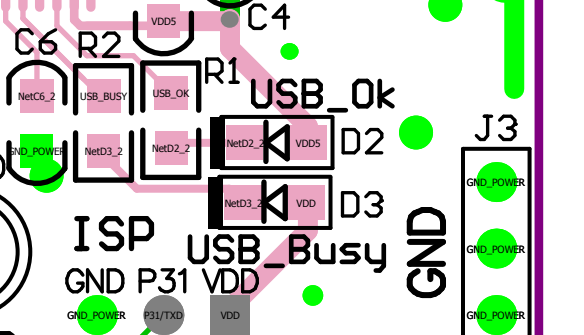
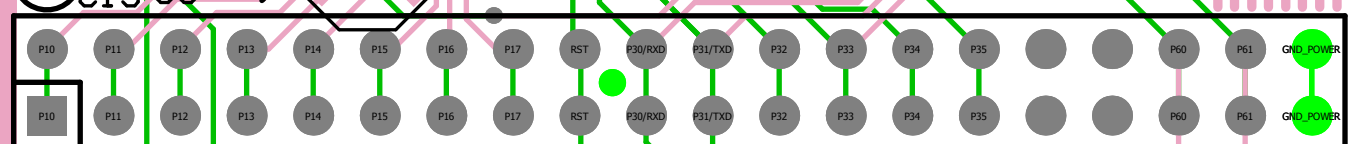
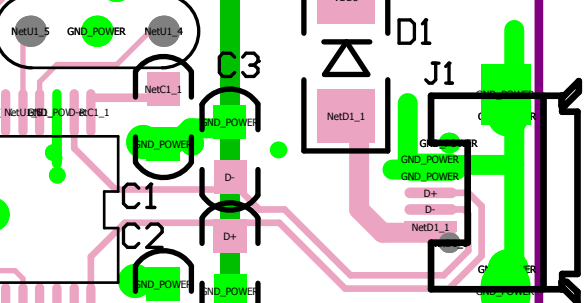
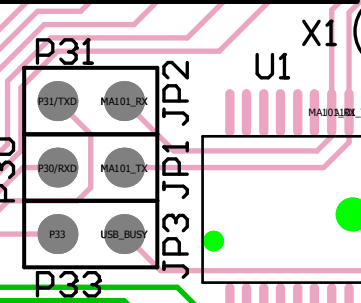
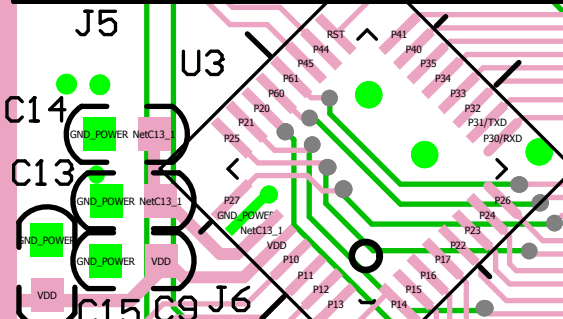
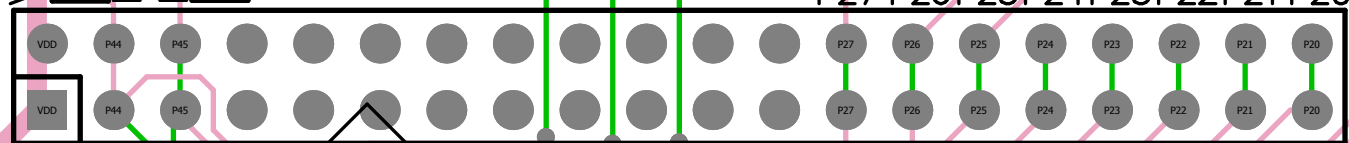
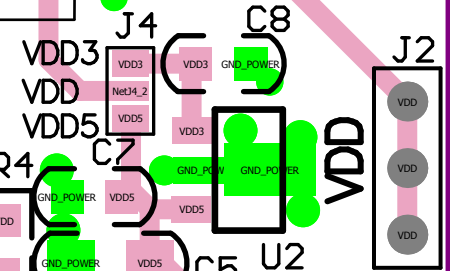
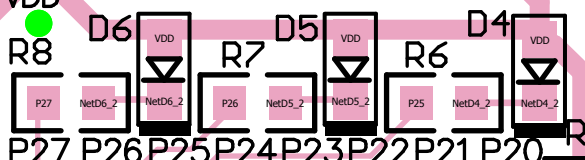
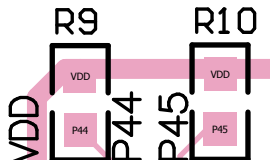
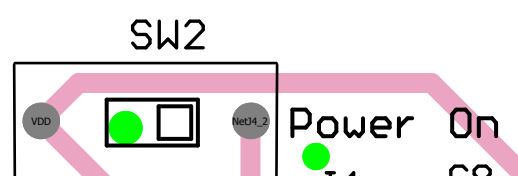
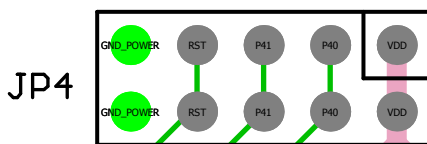

A

B

C

D

A

B

C

D

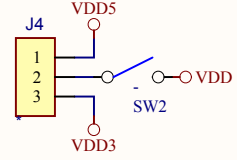
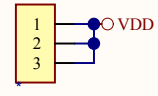
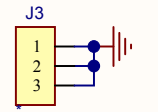
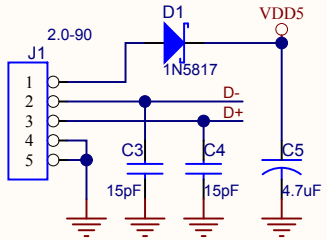

Default: VDD5

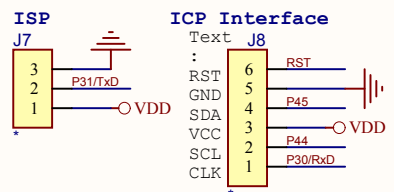
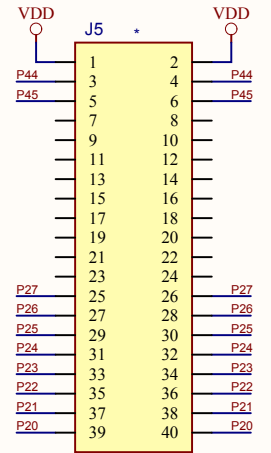
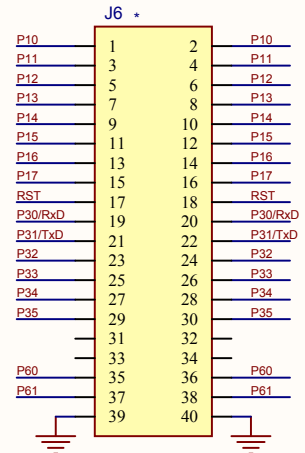
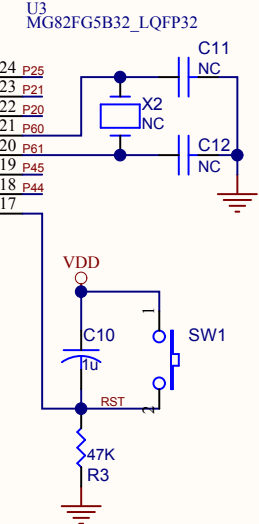
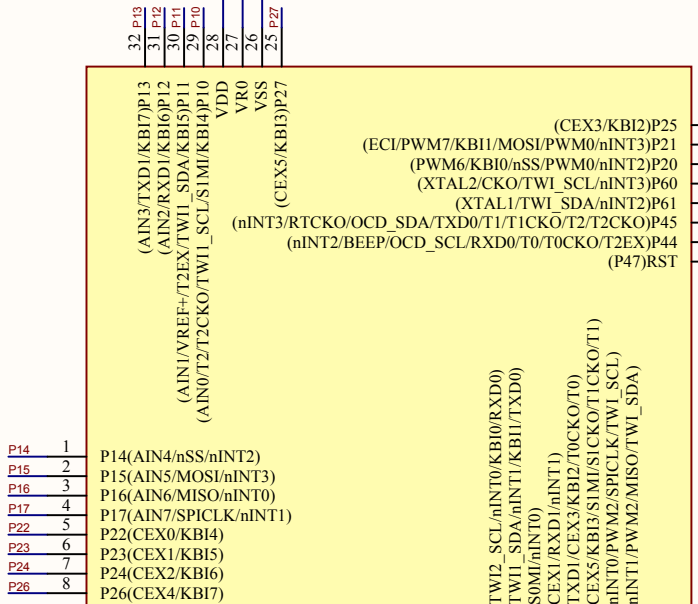
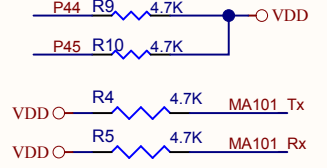
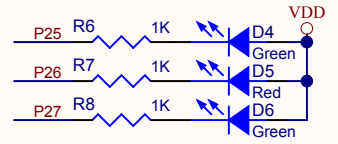
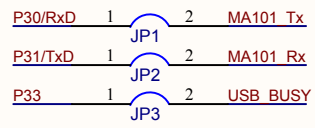
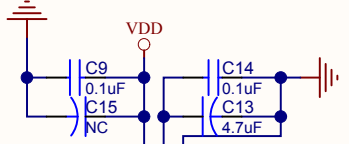
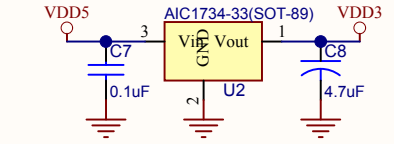
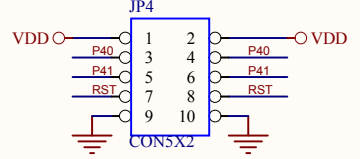
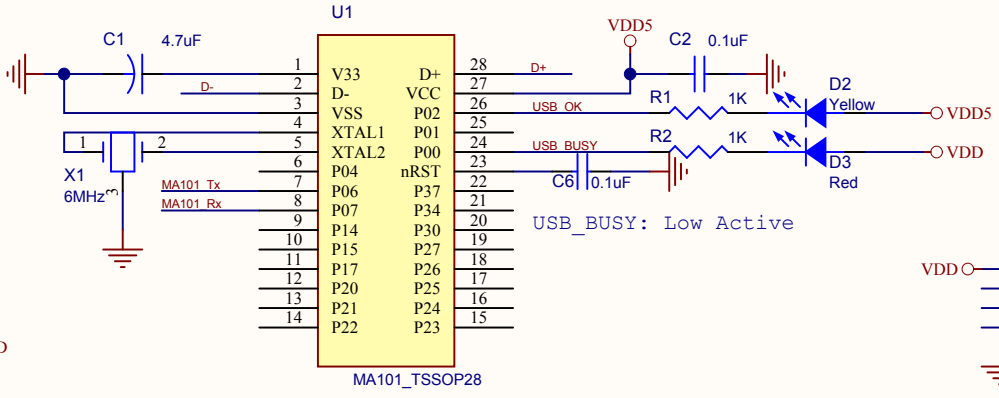

**MEGAWIN 笙泉科技股份有限公司**  
MAKE YOU WIN

http://www.megawin.com.tw TEL:886-3-5750050 FAX:886-3-5750070

Document Number: TH156B MG82FG5B32 LQFP32 EV V11.SchDoc

Size A4	Date 2015/2/24	Sheet 1 of 1
---------	----------------	--------------